

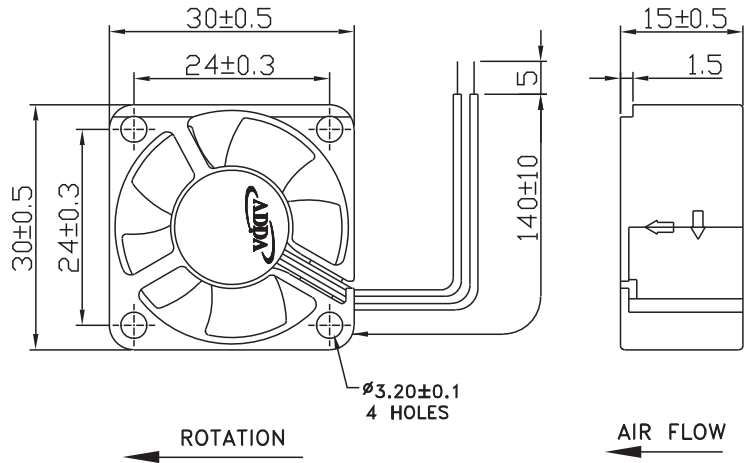

# AD3015 SERIES



## External Dimensions



Frame:Plastic(UL:94V-0)  
 Impeller:Plastic(UL:94V-0)  
 Lead wire:UL1571AWG28

## Specifications(Nominal)

\*:Noise is measured at the distance of one (1) meter from the axis of intake.

Bearing type: ⊙=Ball ⊛=Sleeve ○=1B1S ●=Hypro bearing

Frame size (mm)	Model No.	Bearing System Type	Rated Voltage (VDC)	Current (A)	Power (W)	Rated Speed (rpm)	Maximum AirFlow (CMM)	Maximum AirFlow (CFM)	Maximum Pressure (InAq)	Maximum Pressure (mmAq)	*Noise Level (dB/A)	Weight (g)
30x30x15	AD0305LB-D50	⊙	5	0.038	0.190	4500	0.062	2.20	0.045	1.13	10.0	10.0
	AD0305MB-D50	⊙	5	0.055	0.275	5500	0.074	2.60	0.074	1.50	16.0	
	AD0305HB-D50	⊙	5	0.110	0.550	7000	0.105	3.70	0.110	2.75	22.5	

Specifications subject to change without notice.

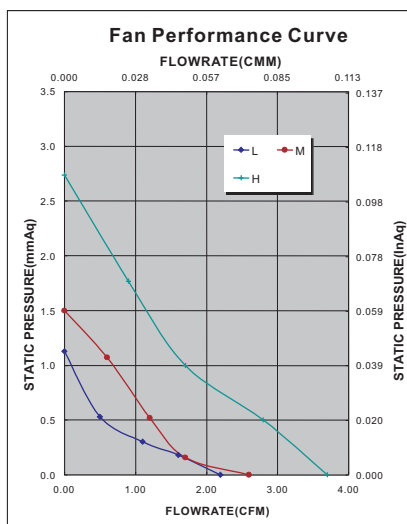

\*Motor protective circuit and third lead wire functions

0	1	2	3	4	6	7	8	9	A	B
✓	✓		✓		✓					

\*Safety approvals

✓	✓		✓	✓